

S1=S2=S3=S6=S7  
PLANTA  
ESC 1:25

CORTE  
ESC 1:25

P1=P2=P3=P6=P7

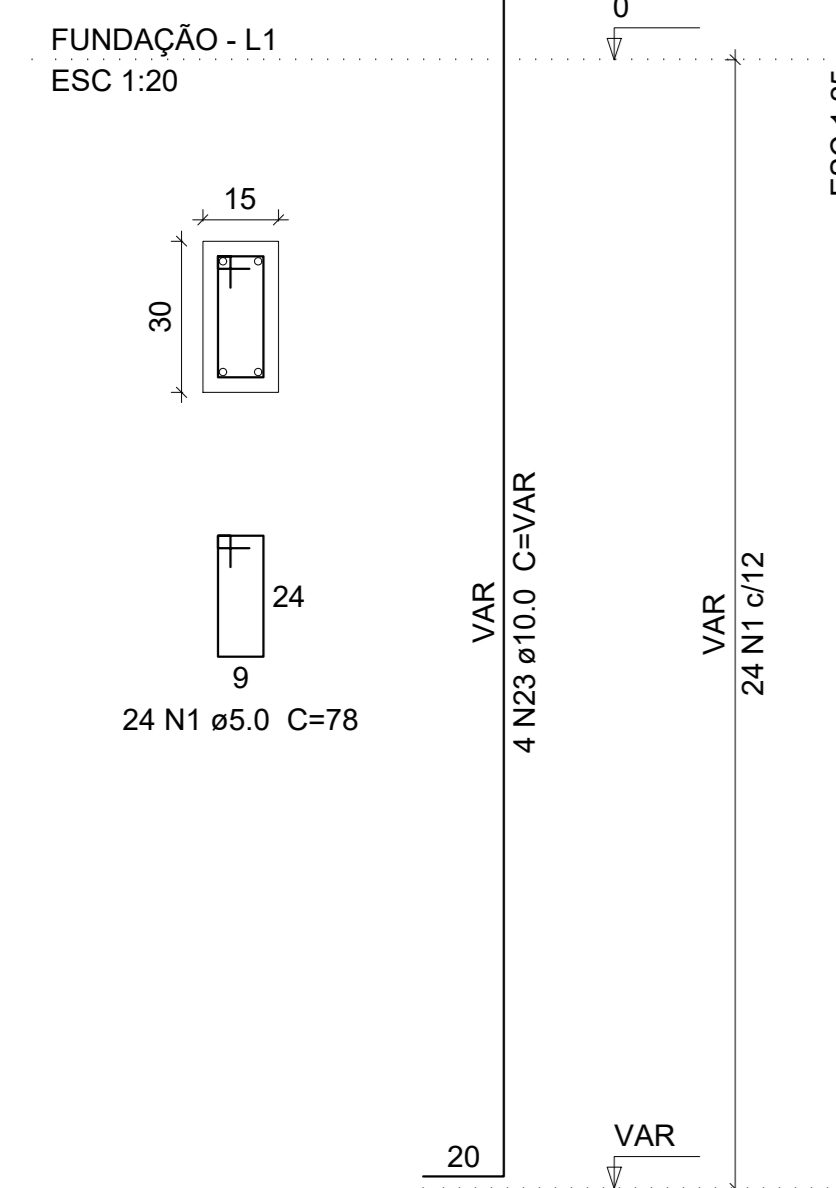

Solo com capacidade de suporte > 1.50 kgf/cm²  
Solo compactado sobre a sapata  
peso específico > 1600.00 kg/m³

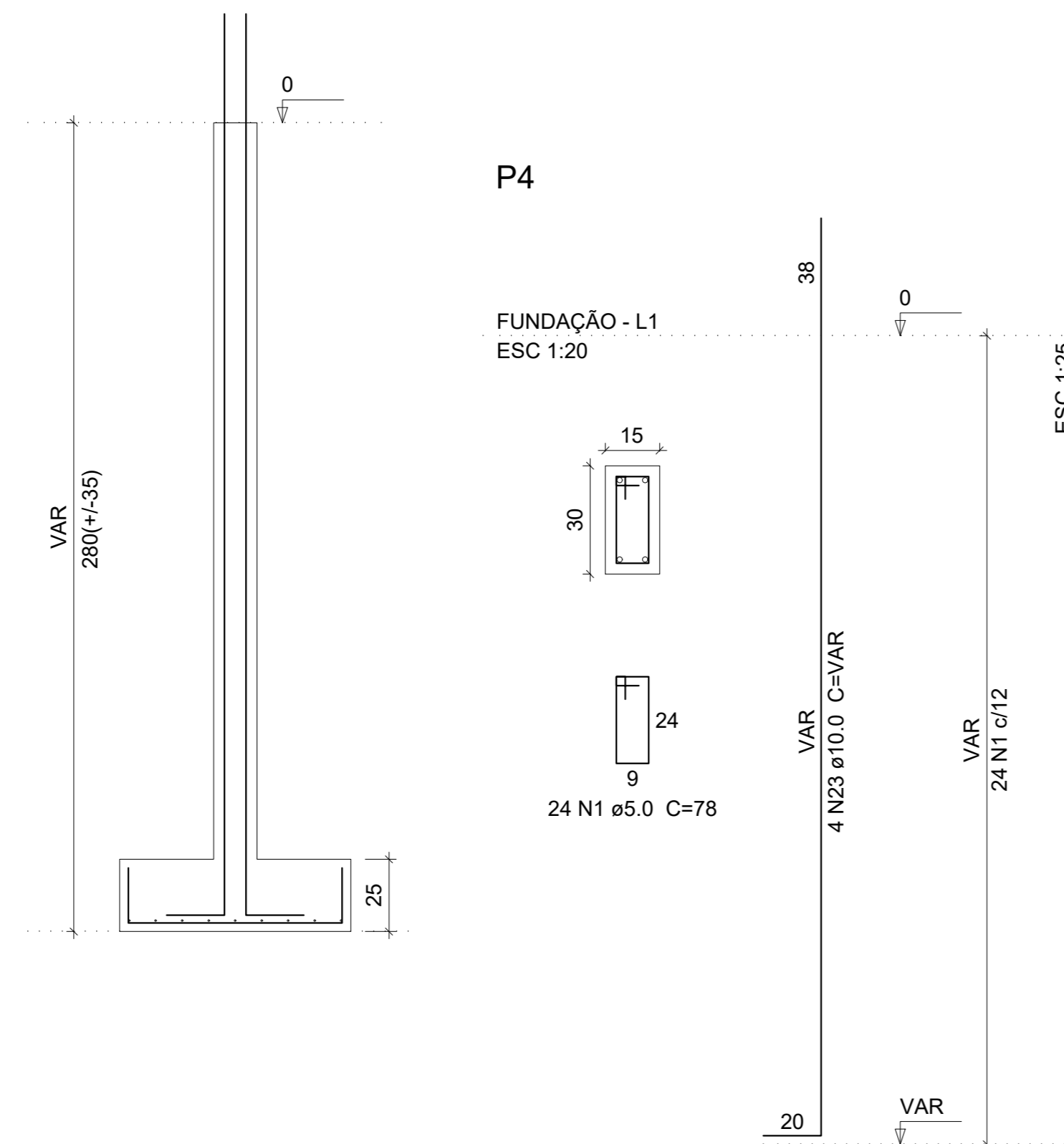

S4  
PLANTA  
ESC 1:25

CORTE  
ESC 1:25

P4

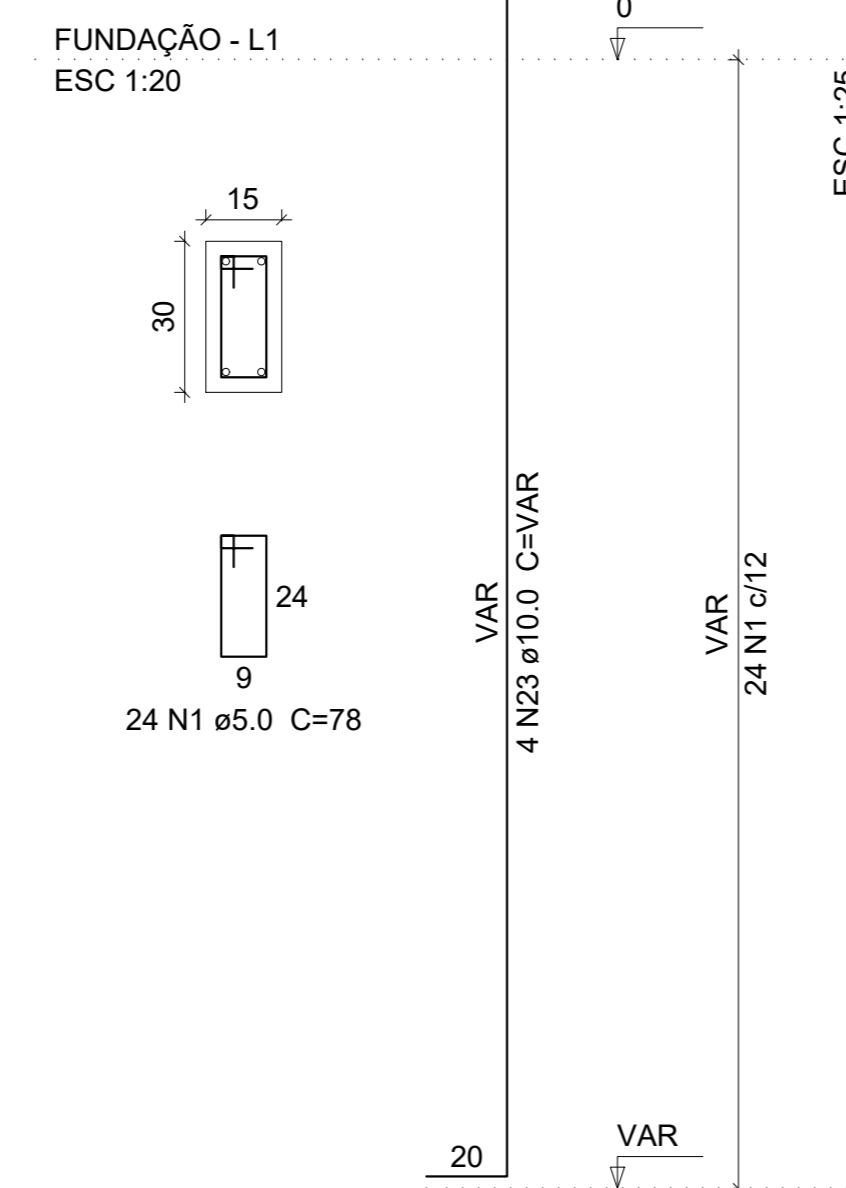

Solo com capacidade de suporte > 1.50 kgf/cm²  
Solo compactado sobre a sapata  
peso específico > 1600.00 kg/m³

S5  
PLANTA  
ESC 1:25

CORTE  
ESC 1:25

P5

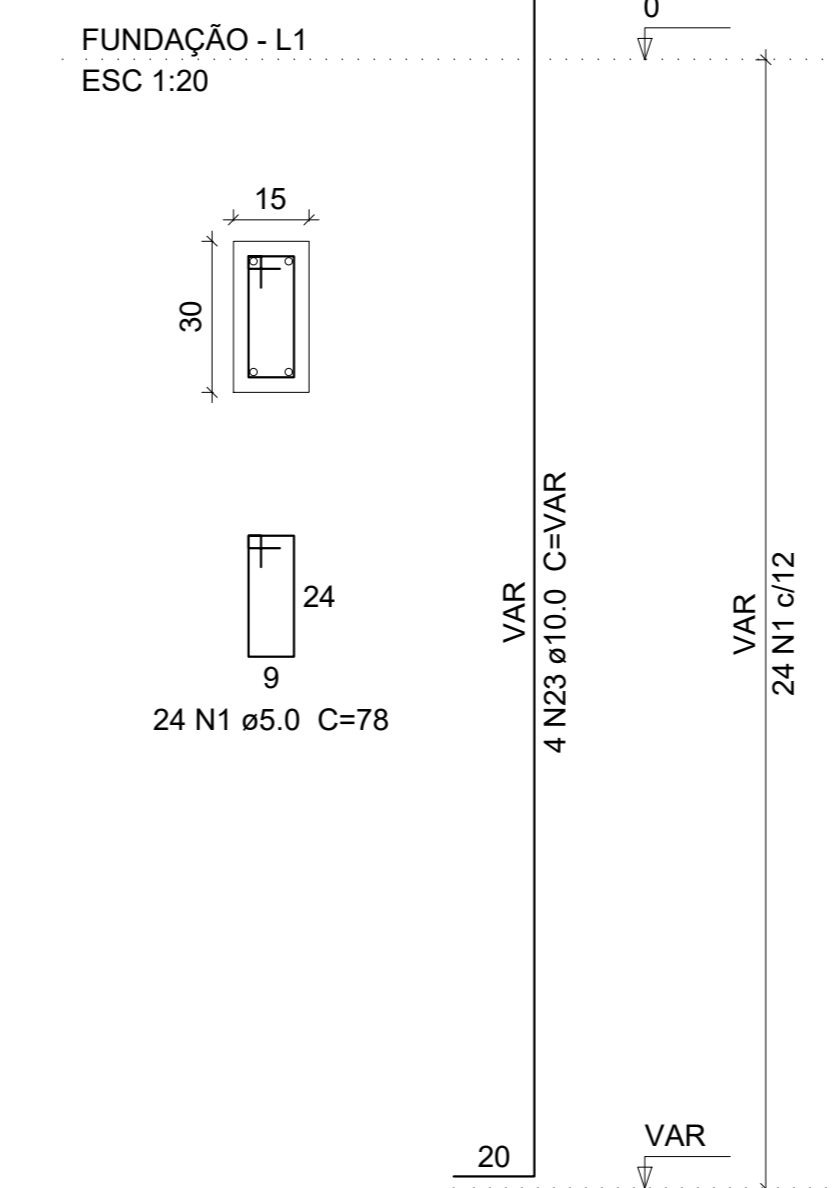

Solo com capacidade de suporte > 1.50 kgf/cm²  
Solo compactado sobre a sapata  
peso específico > 1600.00 kg/m³

Relação do aço

Fundação:	5xS2	S4
	S5	V1
	V2	V3
	V4	V5
	V6	V7
	V8	V9
	V10	V9
Terreo:	7xP1	V1
	V4	V3
	V6	V5
	V8	V7
	V10	V9

AÇO	N	DIAM	Q	UNIT (cm)	C.TOTAL (cm)
CA60	1	5.0	791	78	61698
	2	5.0	4	115	460
CA50	3	6.3	50	109	5450
	4	6.3	45	124	5580
	5	6.3	12	129	1548
	6	6.3	8	89	712
	7	6.3	6	104	624
	8	8.0	9	113	1017
	9	8.0	14	468	6552
	10	8.0	8	123	984
	11	8.0	4	155	620
	12	8.0	1	129	129
	13	8.0	1	316	316
	14	8.0	8	509	4072
	15	8.0	12	545	6540
	16	8.0	8	267	2136
	17	8.0	7	304	2128
	18	8.0	3	303	909
	19	8.0	2	506	1012
	20	8.0	2	504	1008
	21	8.0	2	505	1010
	22	8.0	4	525	2100
	23	10.0	28	VAR	VAR
	24	10.0	1	132	132
	25	10.0	4	487	1948
	26	10.0	1	167	167
	27	10.0	28	287	8036

Resumo do aço

AÇO	DIAM	C.TOTAL (m)	PESO + 10% (kg)
CA50	6.3	139.2	37.5
	8.0	305.4	132.5
	10.0	197	133.5
CA60	5.0	621.6	105.4
PESO TOTAL			
CA50		303.5	
CA60		105.4	

Vol. de concreto total (C-25) = 6.47 m³  
Área de forma total = 97.82 m²

V1  
ESC 1:50

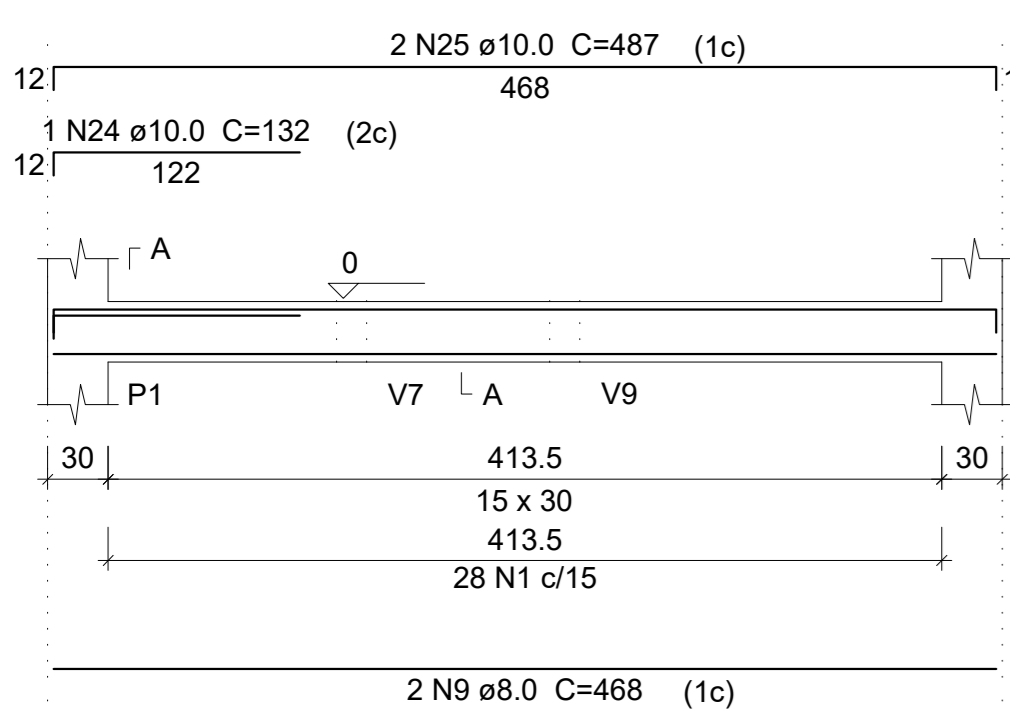

V2  
ESC 1:50

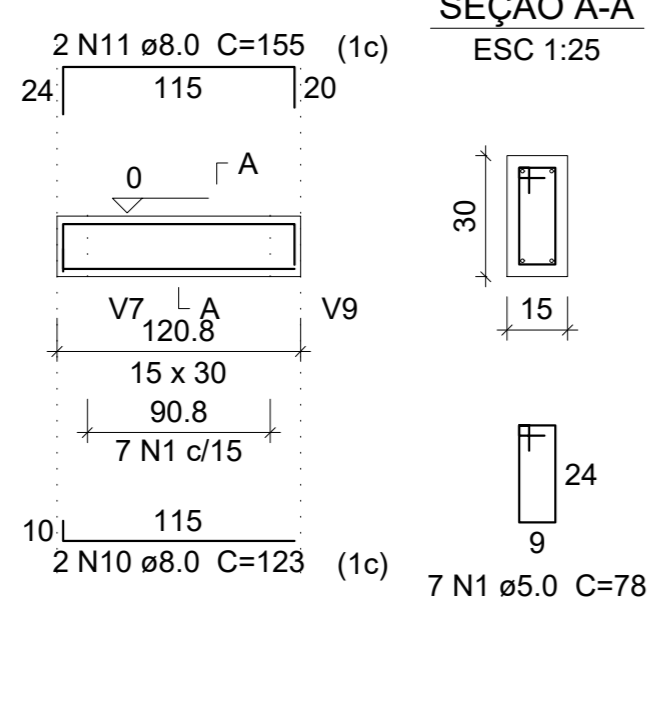

V3  
ESC 1:50

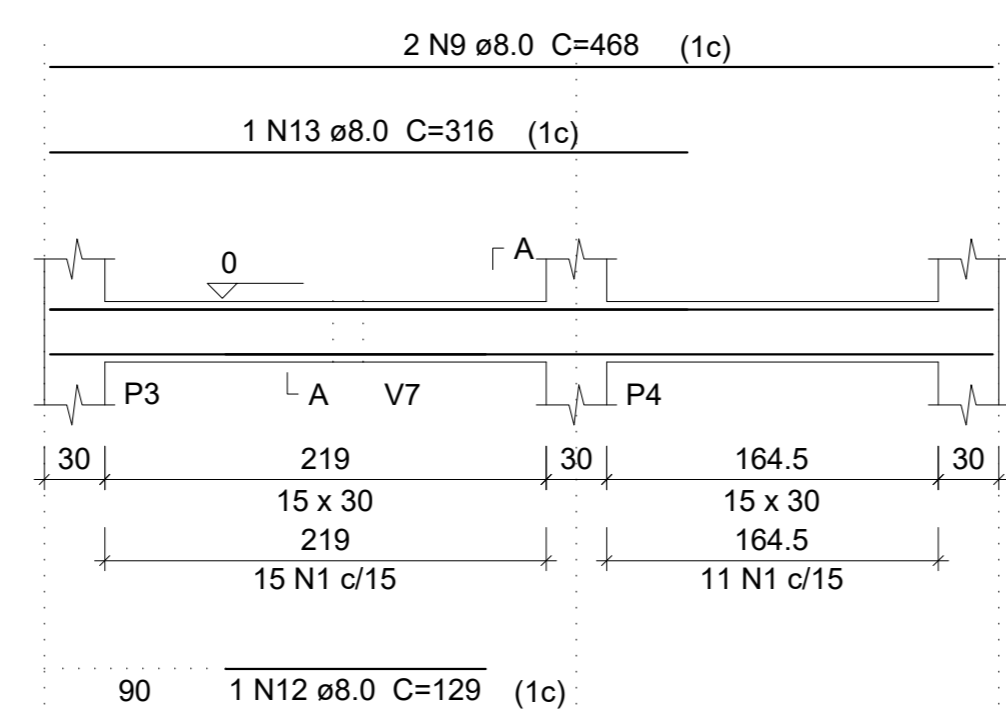

V4  
ESC 1:50

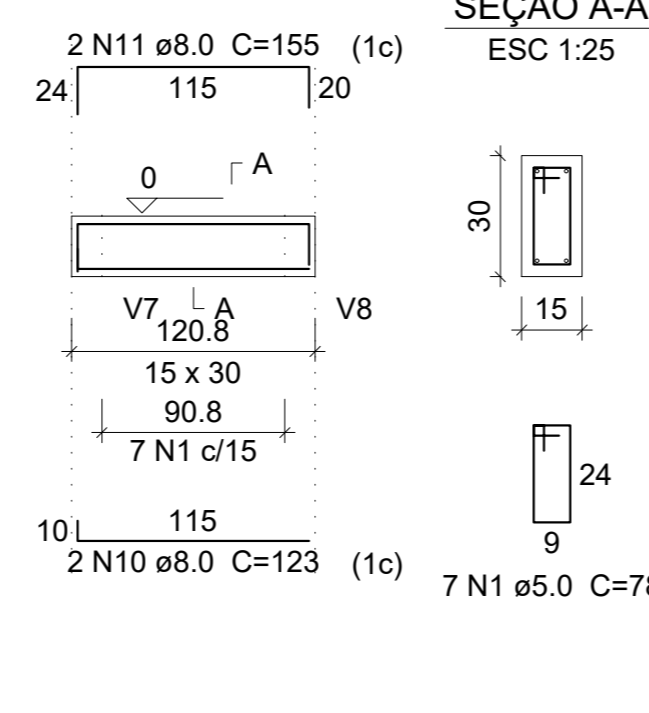

V5  
ESC 1:50

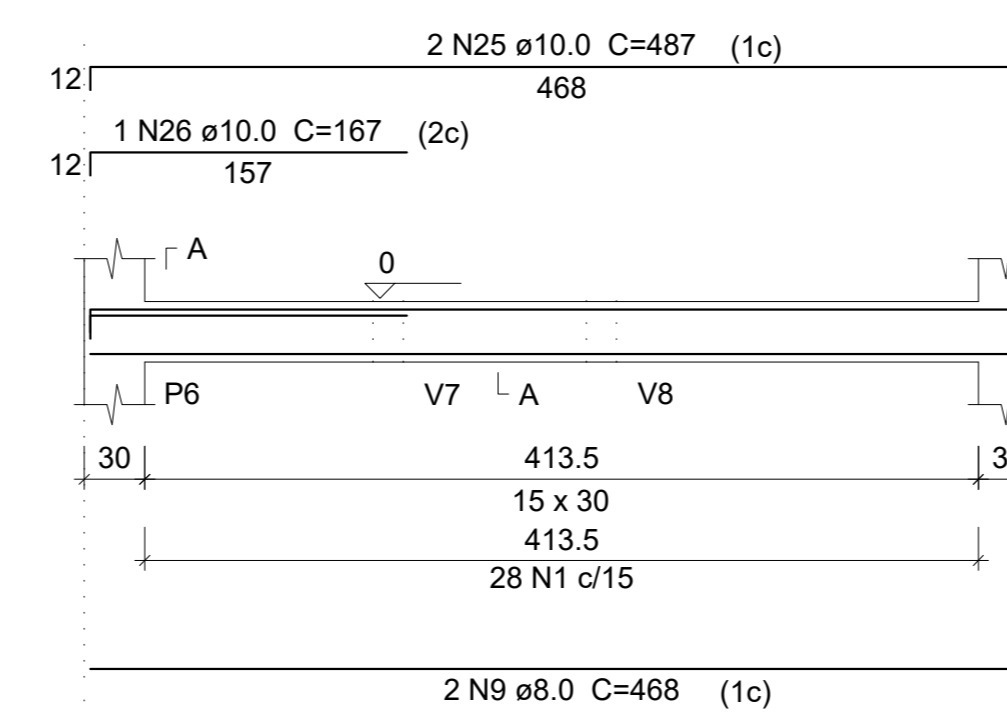

V6  
ESC 1:50

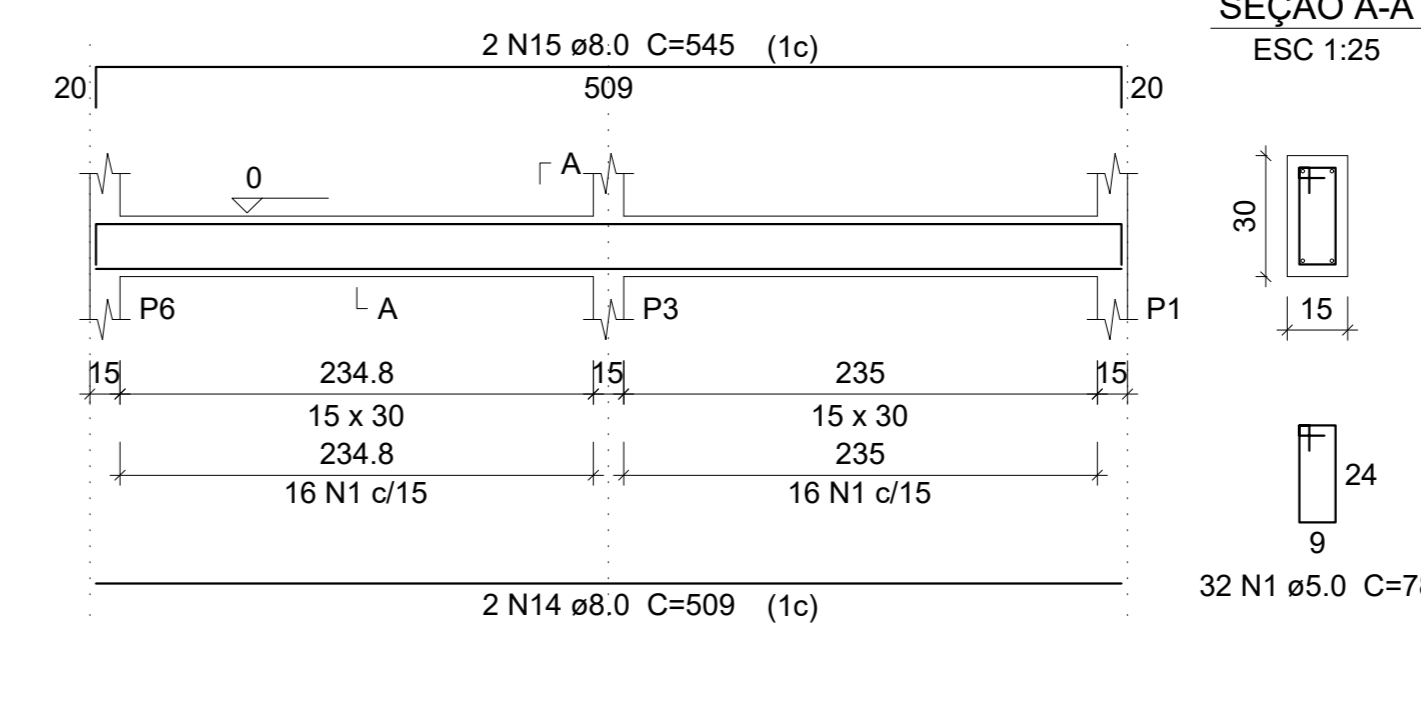

V7  
ESC 1:50

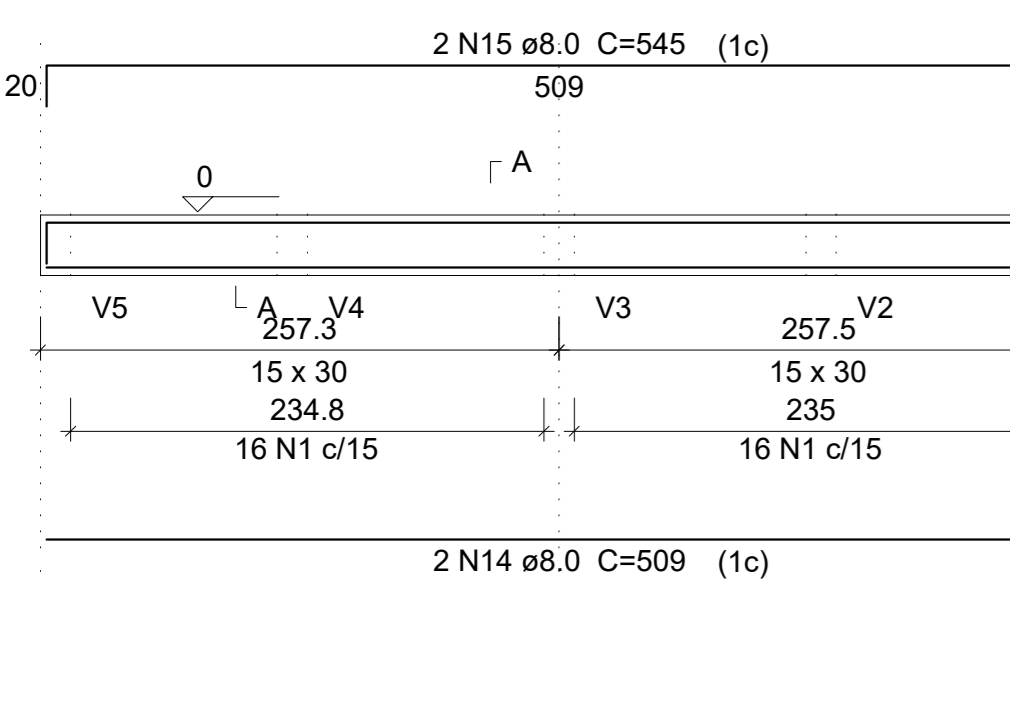

V8  
ESC 1:50

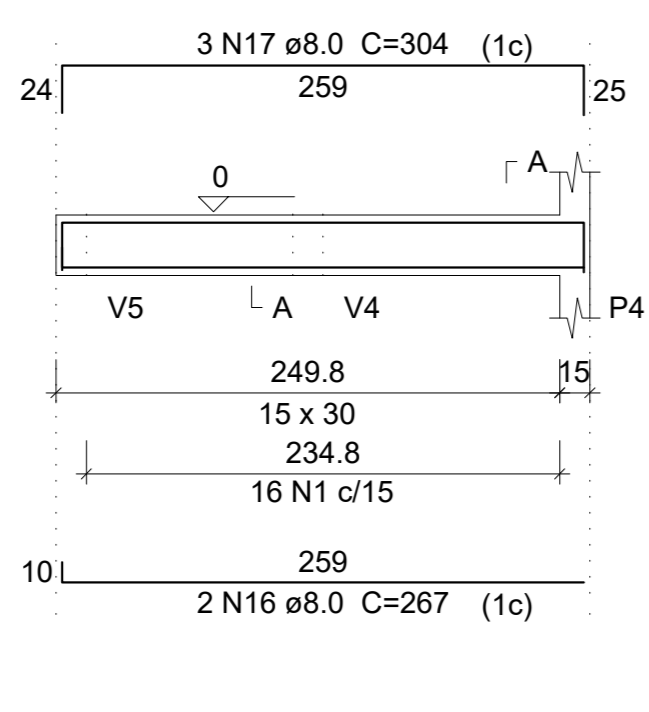

V9  
ESC 1:50

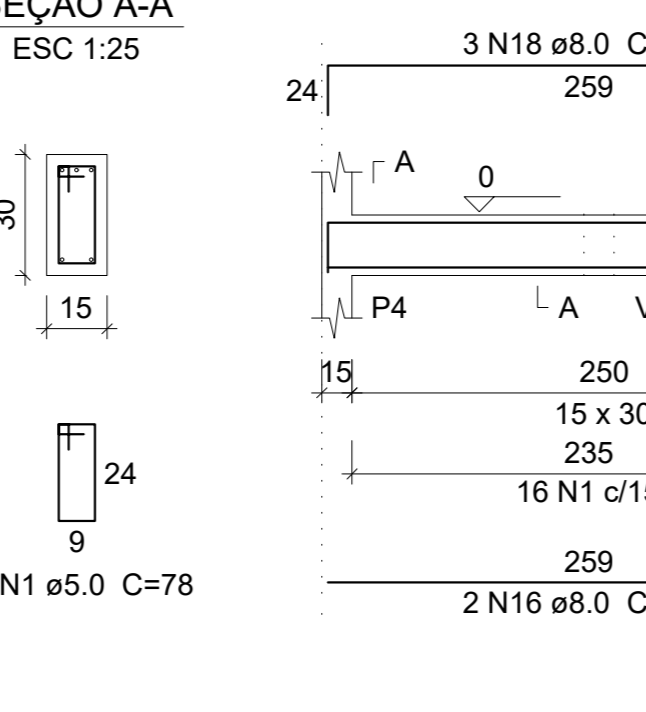

V10  
ESC 1:50

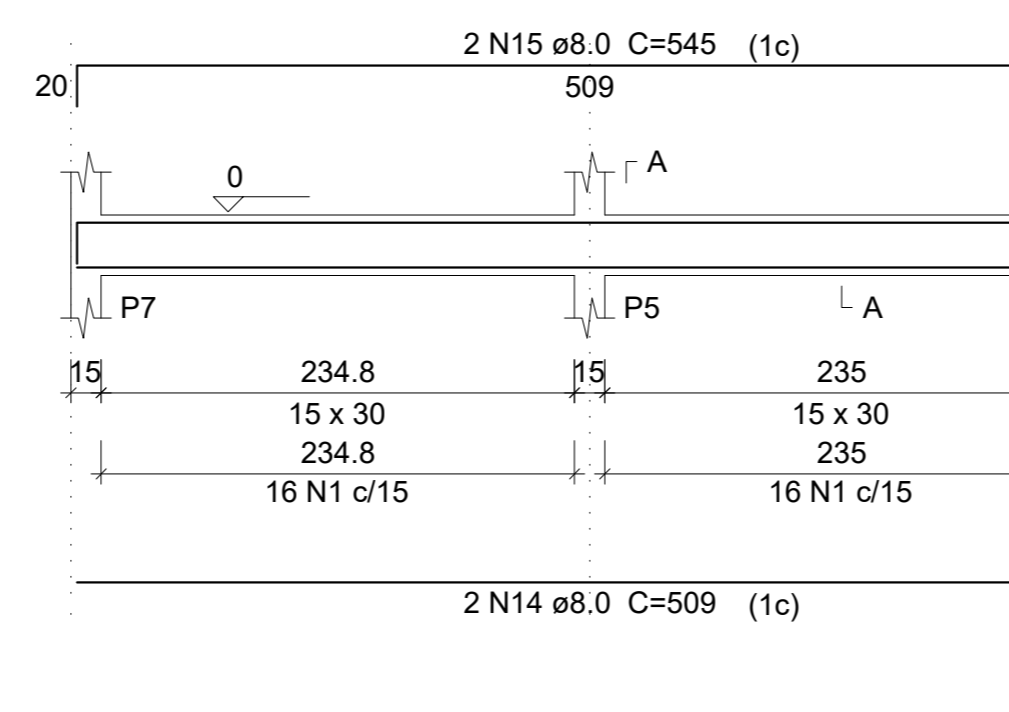

P1=P2=P3=P4=P5=P6=P7

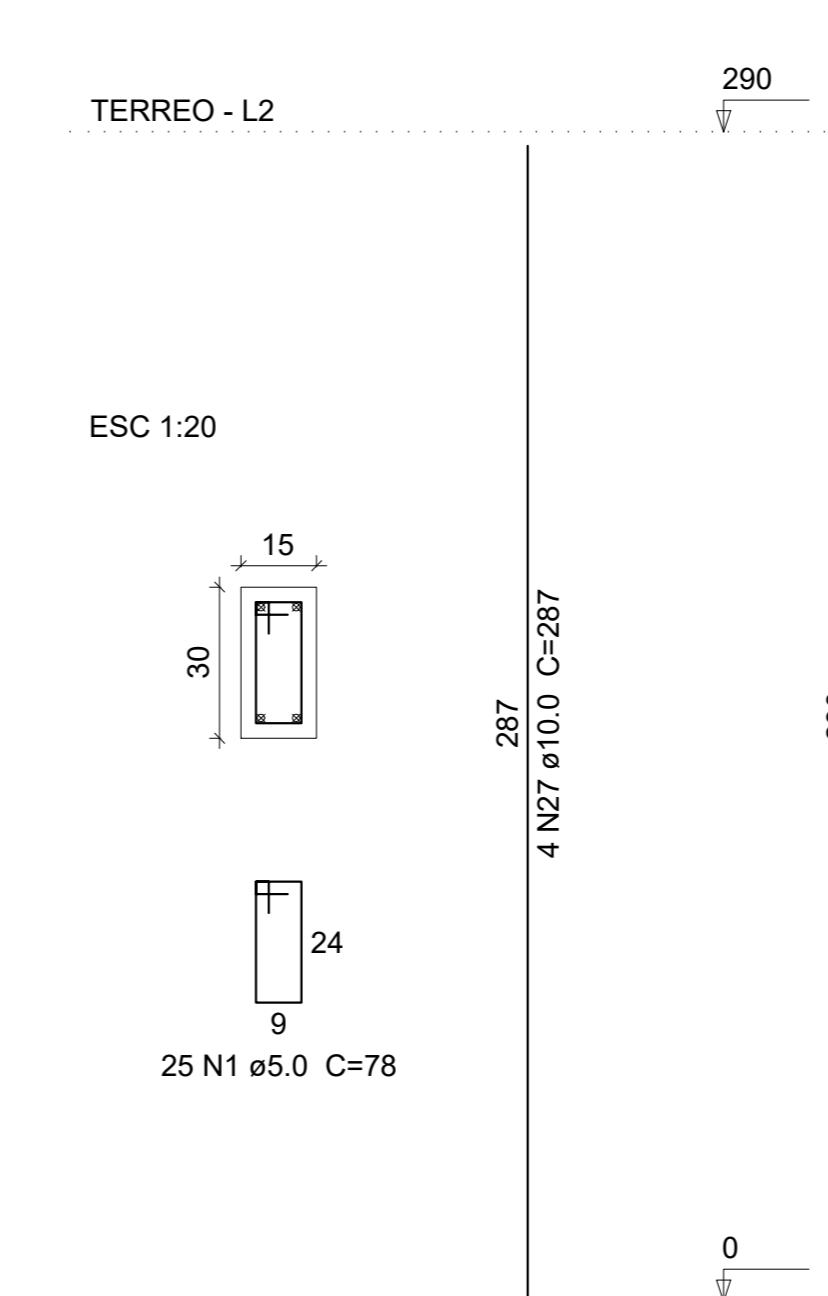

V1  
ESC 1:50

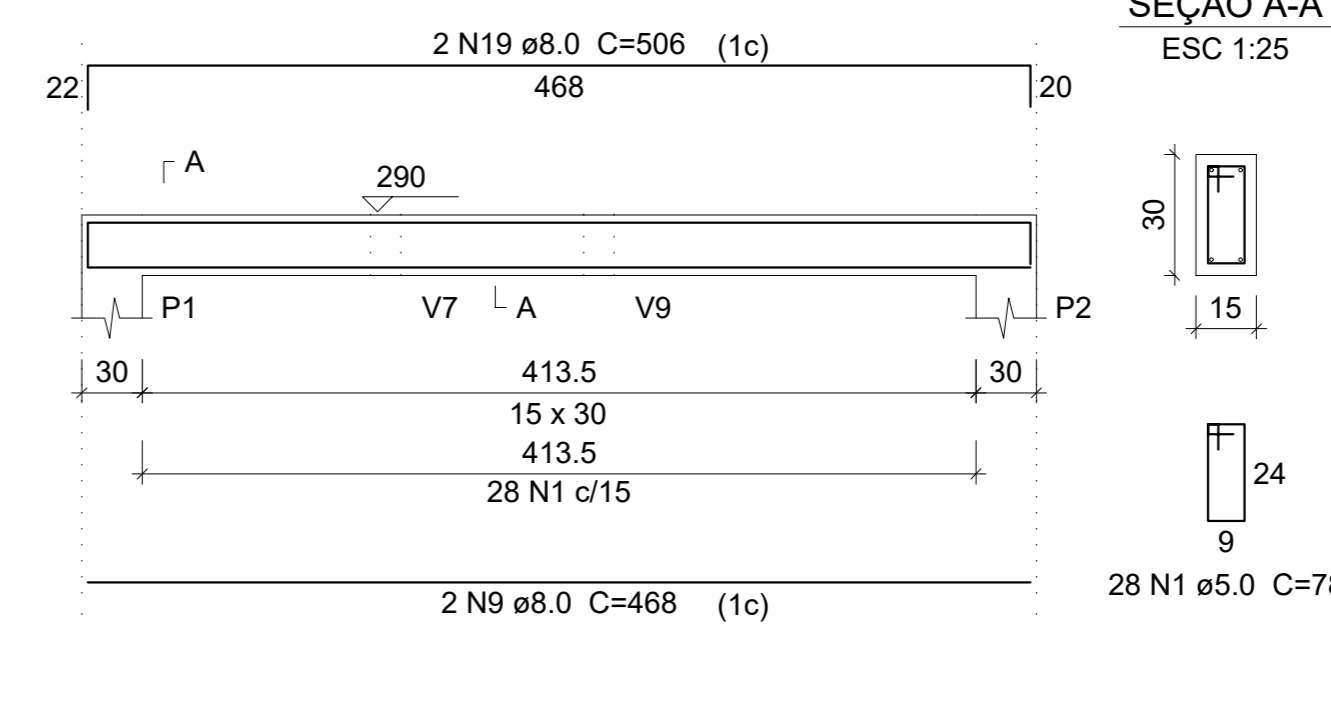

V2  
ESC 1:50

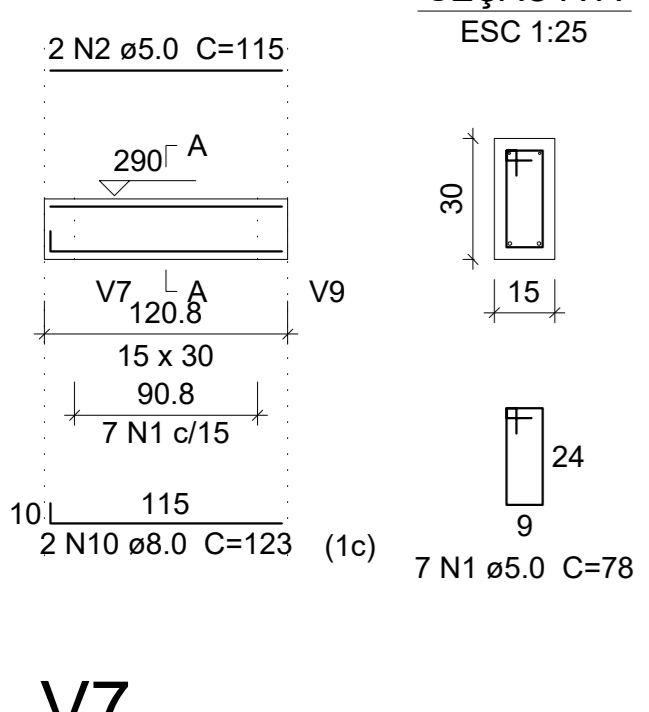

V3  
ESC 1:50

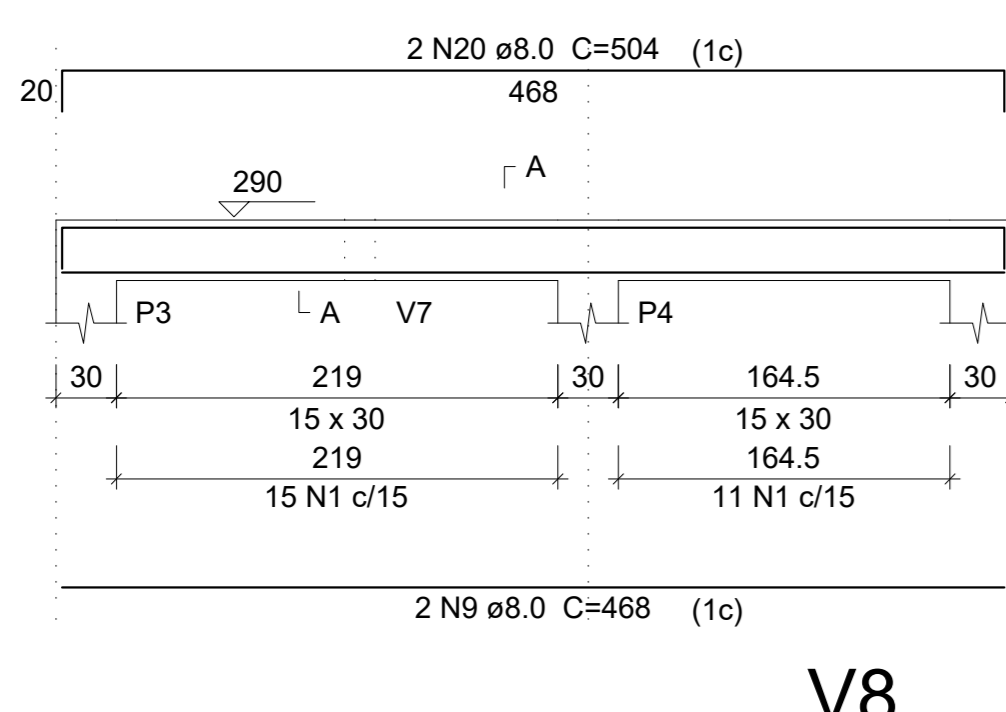

V4  
ESC 1:50

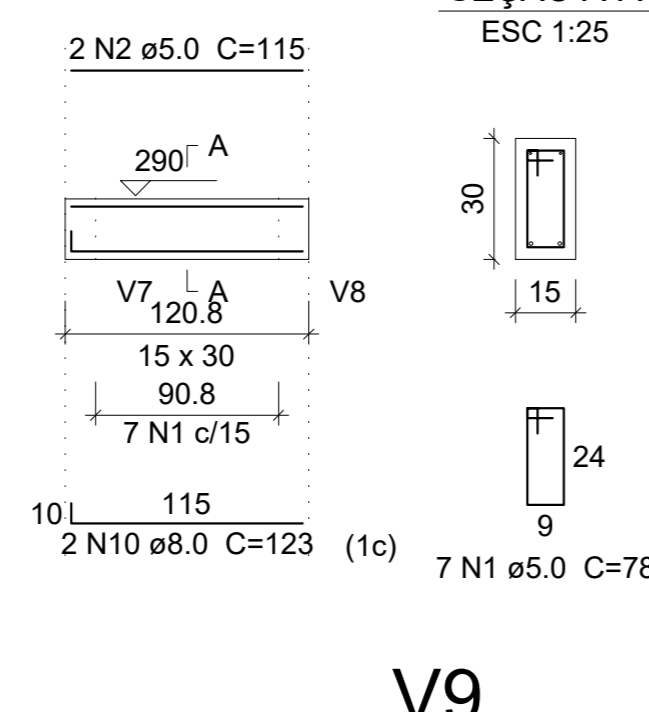

V5  
ESC 1:50

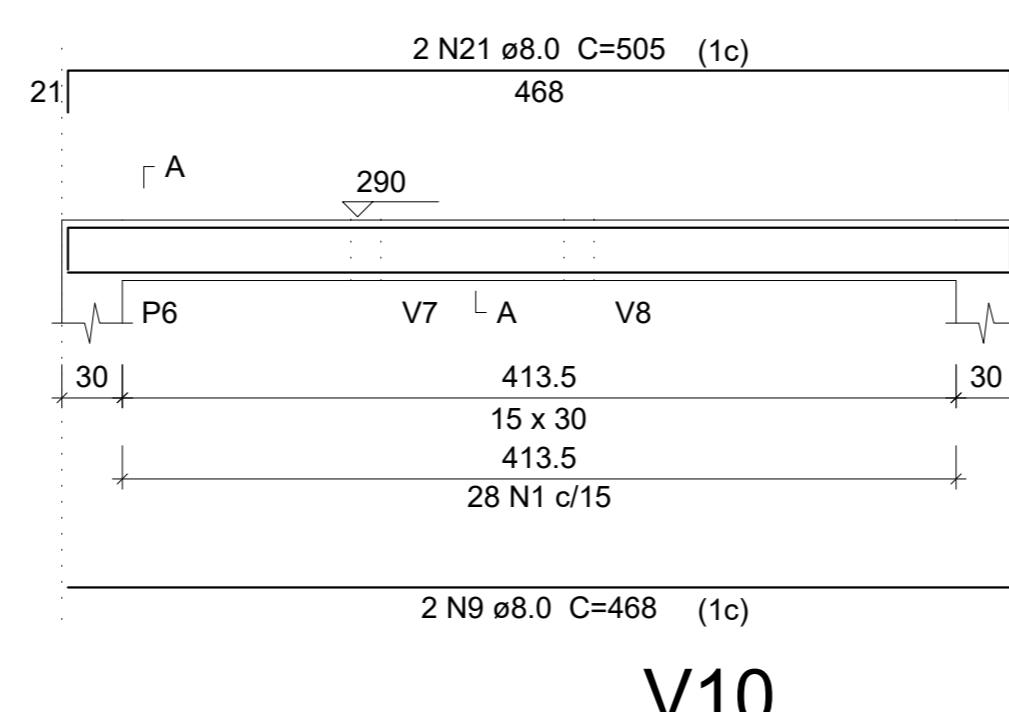

V6  
ESC 1:50

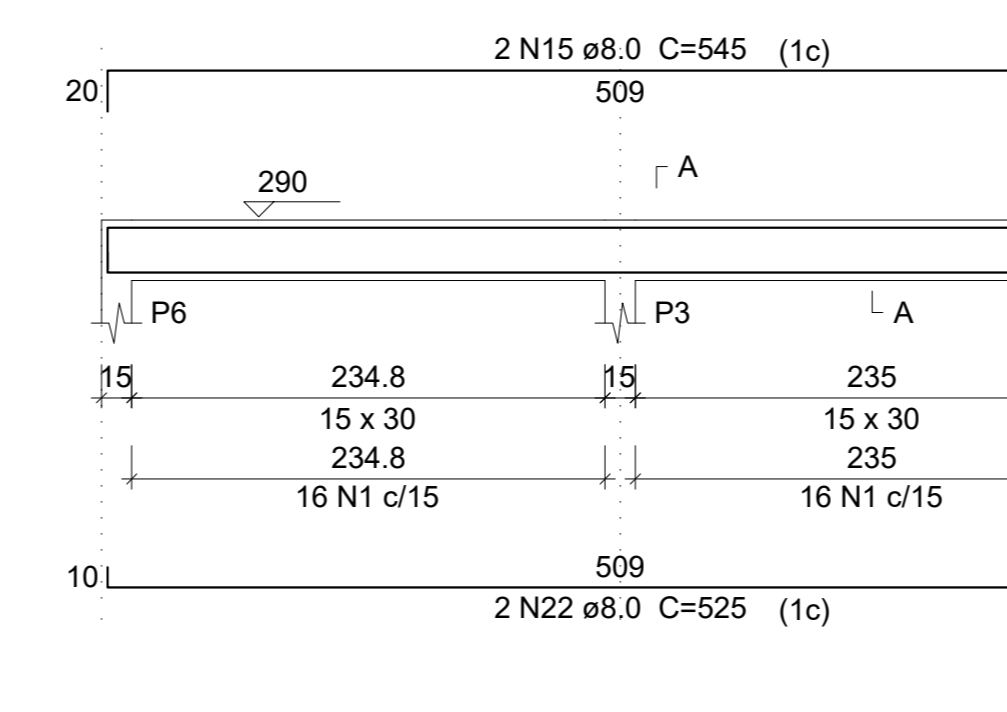

V7  
ESC 1:50

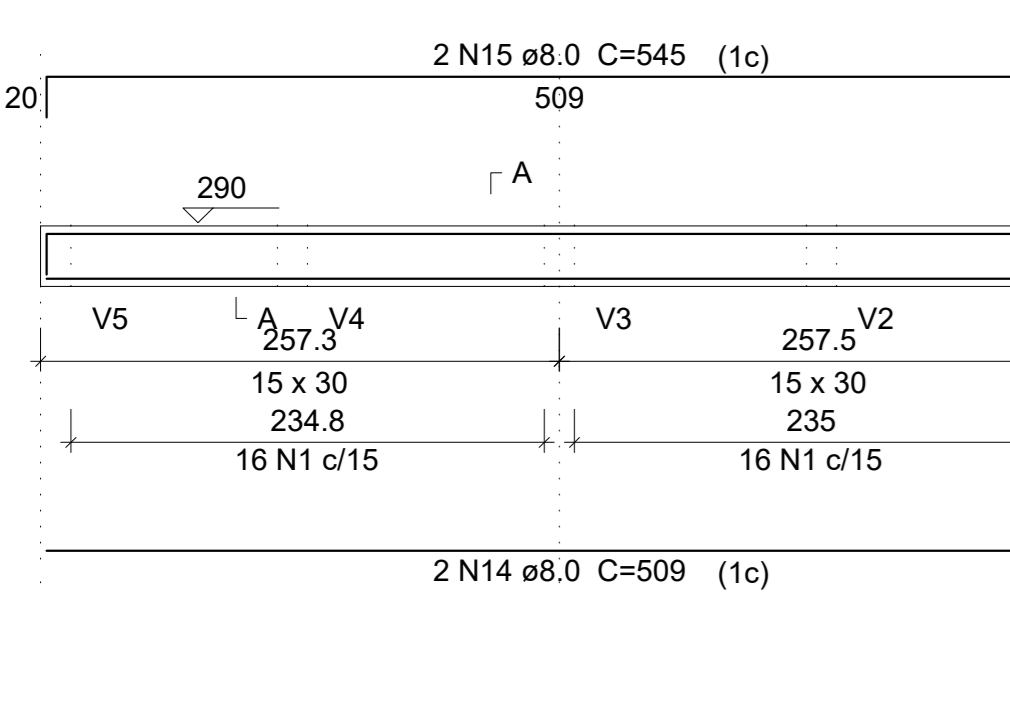

V8  
ESC 1:50

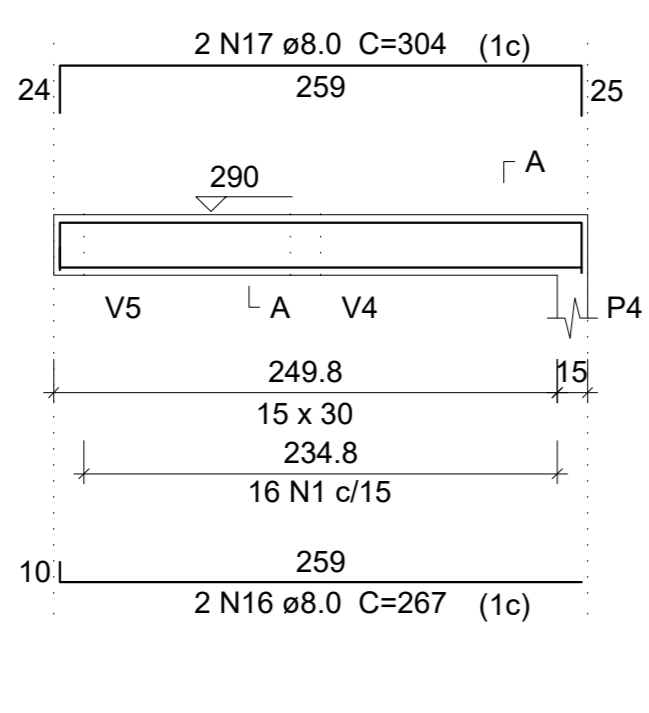

V9  
ESC 1:50

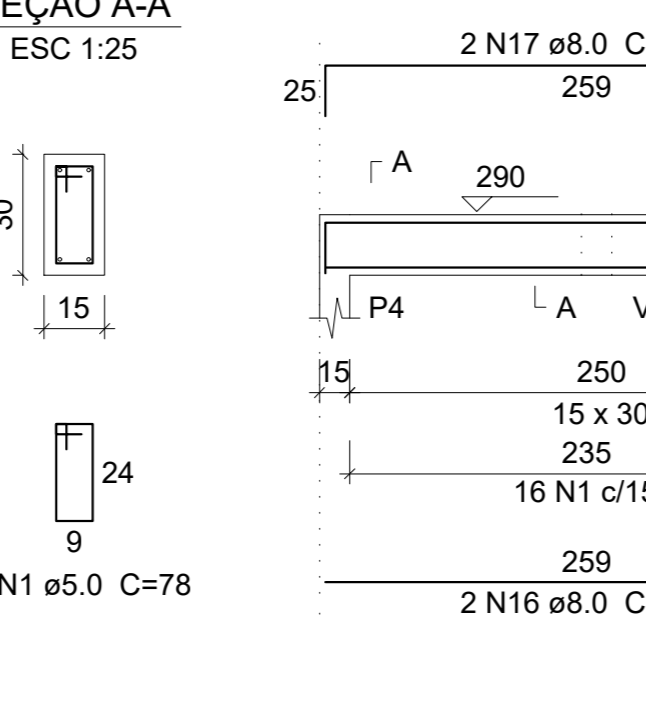

V10  
ESC 1:50

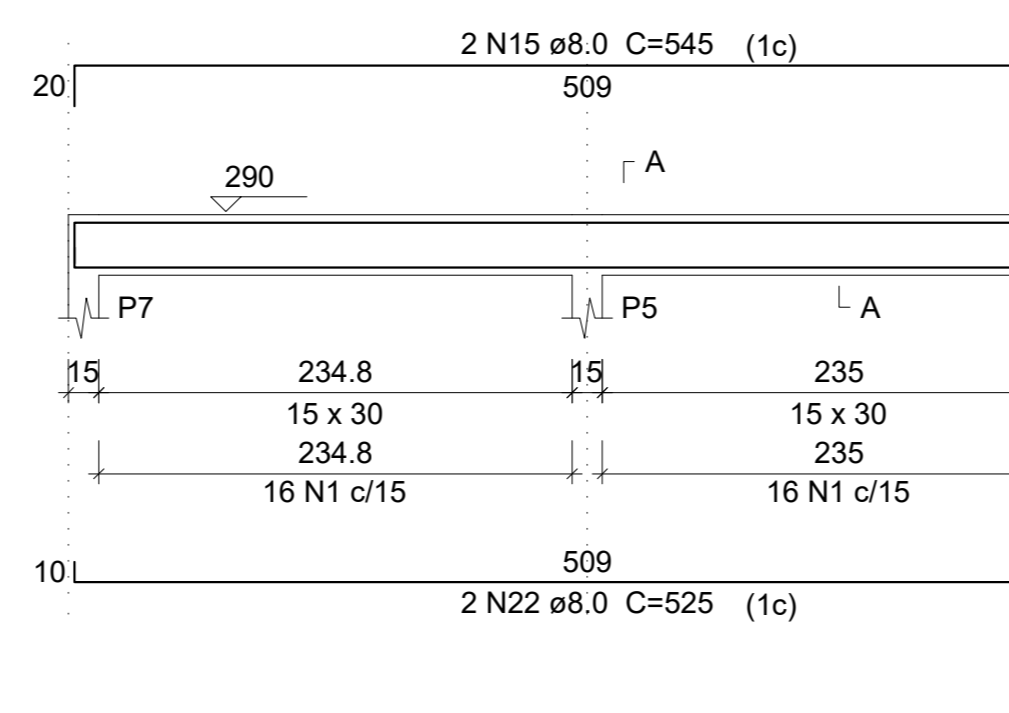

PROJETO

**PROJETO ESTRUTURAL - VESTIÁRIO**

OBRA

Praça de Esportes - Vestiário

LOCAL

Avenida Presidente Tancredo de Almeida Neves, N°220, Bairro Novo Horizonte

PROPRIETÁRIO

Prefeitura Municipal de Luminárias - CNPJ: 18.244.301/0001-26

RESPONSÁVEL TÉCNICO

Adalgiane Souza Monteiro - CREA/MG: 204995-D

ÁREA

24,37 m²

DATA

11/04/2024

ESCALA

INDICADA

FOLHA

02/04